

GV-EFD5101 5MP H.264 Low Lux WDR IR Fixed IP Dome



- 1/3.2" progressive scan low lux CMOS
- Dual streams from H.264 and MJPEG
- Up to 30 fps at 2592 x 1944
- Intelligent IR
- Day and Night function (with removable IR-cut filter)
- Megapixel varifocal lens
- P-Iris lens for auto Iris control
- IR distance up to 30 m (98.4 ft)
- 3-axis mechanism (pan / tilt / rotate)
- DC 12V / PoE (IEEE 802.3af)
- Two-way audio
- Wide Dynamic Range (WDR)
- 3D noise reduction
- Defog
- Motion detection
- Tampering alarm
- Text overlay
- Privacy mask
- IP address filtering
- Supports iPhone, iPad, Android & 3GPP
- 31 languages on Web interface
- ONVIF (Profile S) conformant
- More storage option - NAS

Introduction

GV-EFD5101 is an indoor, fixed network camera. Its features such as WDR, automatic IR-cut filter, Low Lux and IR LEDs enable day and night surveillance. Adjustable in 3 axis (pan, tilt and rotate), it offers an entry-level surveillance solution with all the essential features and excellent image quality.

Active Tampering Alarm

Tampered



Focus Change



Camera Shift



Dimensions

Hard-Ceiling Mount

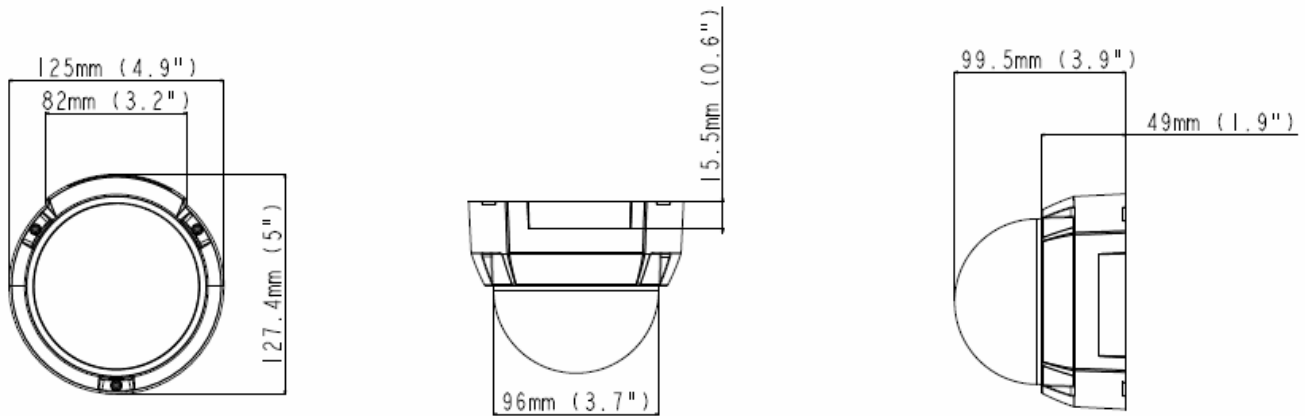

In-Ceiling Mount

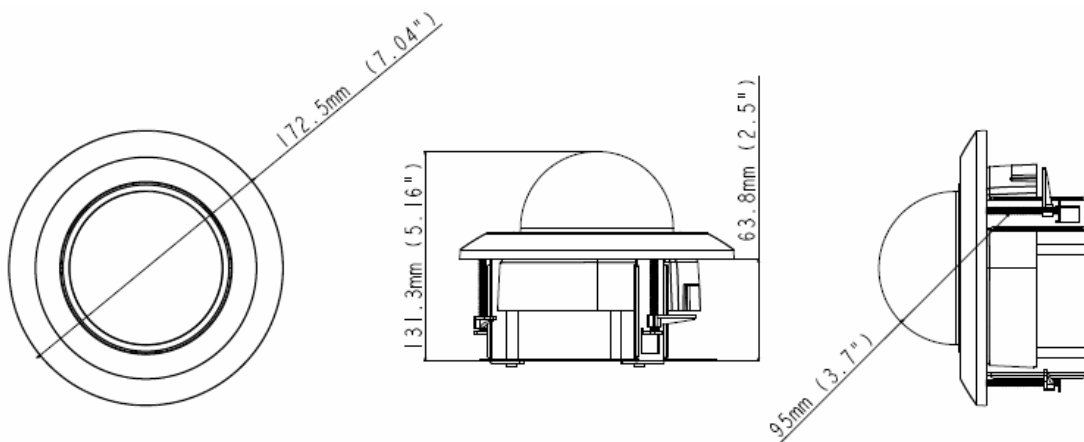

Specifications

PC Requirements		
CPU		Intel Core i5-4670 @ 3.40 GHz
Memory		DDR3 4 GB RAM
On Board Graphics		Intel HD Graphics 4600 (Versions of driver from year 2014 or later required)
Camera		
Image Sensor		1/3.2" progressive scan low lux CMOS
Picture Elements		2592 (H) x 1944 (V)
Minimum Illumination	Color	0.12 Lux
	B/W	0.10 Lux
	IR ON	0 Lux
Shutter Speed		Automatic, Manual (1/5 ~ 1/8000 sec.)
White Balance		Automatic, Manual (2800K ~ 8500K)
Gain Control		Automatic
S/N Ratio		46 dB
WDR		Yes
Dynamic Range		Up to 72 dB
Lens		
Megapixel		Yes
Day/Night		Yes (with removable IR-cut filter)

Focal Length	3 ~ 9 mm	
Lens Type	Varifocal	
Maximum Aperture	F/1.7	
Mount	Ø14 mm	
Horizontal FOV	92° ~ 32°	
Image Format	1/3.2"	
Operation	Focus	Manual (w/lock)
	Zoom	Manual (w/lock)
	Iris	P-Iris
Max. Torque (Focus / Zoom Screws)	0.049 N.m	
IR LED Quantity	20 IR LEDs	
Max. IR Distance	30 m (98.4 ft)	
Operation		
Video Compression	H.264, MJPEG	
Video Streaming	Dual streams from H.264 and MJPEG	
Frame Rate	30 fps at 2592 x 1944 (60/50 Hz) * The frame rate and the performance may vary depending on the number of connections and data bitrates (different scenes).	
Image Setting	Brightness, Contrast, Saturation, Sharpness, Gamma, White Balance, Flicker-less, Image Orientation, Shutter Speed, D/N Sensitivity, Backlight Compensation, WDR, Defog, Low Lux Enhancement, Noise Reduction	
Audio Compression	G.711, AAC (Optional)	
Audio Support	Two-way Audio	
Video Resolution		
Main Stream	4:3	2592 x 1944 (Default), 2048 x 1536, 1600 x 1200, 1280 x 960, 640 x 480, 320 x 240
	16:9	1920 x 1080, 1280 x 720, 640 x 360, 448 x 252
	5:4	1280 x 1024, 640 x 512, 320 x 256
Sub Stream	4:3	960 x 720 (Default), 640 x 480, 320 x 240
	16:9	640 x 360, 448 x 252
	5:4	640 x 512, 320 x 256
Network		
Interface	10/100 Ethernet	
Ethernet Protocol	DHCP, DynDNS, FTP, HTTP, HTTPS, NTP, ONVIF (Profile S), PSIA, QoS (DSCP), RTSP, SNMP, SMTP, TCP, UDP, UPnP, 3GPP/ISMA	
Mechanical		
Temperature Detector	Yes	
Camera Angle Adjustment	Pan	0° ~ 350°
	Tilt	0° ~ 75°
	Rotate	0° ~ 340°
Connectors	Power	2-pin terminal block, PoE
	Ethernet	Ethernet (10/100 Base-T), RJ-45 cable
	Audio	1 In (microphone phone jack, 3.5 mm / 0.14") 1 Out (stereo phone jack, 3.5 mm / 0.14")
	TV-Out	BNC connector (D1 resolution)
LED Indicator	2 LEDs: Power, Status	
General		
Environment Temperature	Start-up	0 °C ~ 50 °C (32 °F ~ 122 °F)
	Operation	
Humidity	10% to 90% (no condensation)	
Power Source	12V DC / PoE (IEEE 802.3af)	
Max. Power Consumption	7 W	
Dimension	ø 125 x 99.5 mm (4.92 x 3.92")	
Weight	470 g (1.04 lb)	
Regulatory	CE, FCC, RCM, RoHS compliant	
Power over Ethernet		
PoE Standard	PoE (IEEE 802.3af Power over Ethernet / PD)	
PoE Power Supply Type	End-Span	
PoE Power Output	Per Port 48V DC, 350mA. Max. 15.4 watts	

Web Interface	
Installation Management	Web-based configuration
Maintenance	Firmware upgrade through Web Browser or Utility
Access from Web Browser	Camera Live View, Video Recording, Change Video Quality, Bandwidth Control, Image Snapshot, Audio, Picture in Picture, Picture and Picture, Privacy Mask, Text Overlay, Digital PTZ
Language	Arabic / Bulgarian / Czech / Danish / Dutch / English / Finnish / French / German / Greek / Hebrew / Hungarian / Indonesian / Italian / Japanese / Lithuanian / Norwegian / Persian / Polish / Portuguese / Romanian / Russian / Serbian / Simplified Chinese / Slovakian / Slovenian / Spanish / Swedish / Thai / Traditional Chinese / Turkish
Applications	
Network Storage	GV-System (GV-DVR/NVR), GV-Recording Server, GV-VMS
Smart Device Access	GV-Eye for iOS and Android
Live Viewing	Browser (IE, Chrome, Firefox, Safari), Mobile App
CMS Server support	GV-Control Center, GV-Center V2, GV-Vital Sign Monitor

Note:

- Specifications are subject to change without prior notice.
- When the resolution is set at 2592 x 1944:
 - If the camera is switched to single stream (while stream two is deselected) and Noise Reduction is disabled, the frame rate can reach up to 30 FPS.
 - If the camera is switched to dual streams and Noise Reduction is disabled, the frame rate can reach up to 25 FPS.
 - As long as Noise Reduction is enabled, whether the camera is switched to single stream or dual streams, the frame rate will be 15 FPS.







Packing List





- | | |
|----------------------|--------------------------------|
| 1. Target Fixed Dome | 6. Installation Sticker |
| 2. Screw x 3 | 7. GV-IPCAM H.264 Software DVD |
| 3. Screw Anchor x 3 | 8. GV-NVR Software DVD |
| 4. Torx Wrench | 9. Warranty Card |
| 5. TV-Out Wire | |

Note: Power adapters can be purchased upon request.

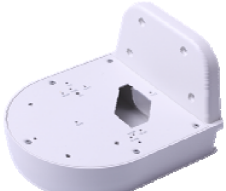
Accessories

Model No.	Name		Details
GV-Mount100	Straight Tube and Junction Box Kit		Dimensions: 200 x 170 x 257.5 mm (7.9 x 6.7 x 10.1") Weight: 3.17 kg (6.99 lb)
GV-Mount101	Straight Tube Kit		Dimensions: 219 x 125 x 332 mm (8.6 x 4.9 x 13.1") Weight: 1.8 kg (3.97 lb)
GV-Mount200	Wall Pendant Tube		Dimensions: 225 x 140 x 250 mm (8.9 x 5.5 x 9.8") Weight: 900 g (1.98 lb)

GV-Mount203	Wall Pendant Tube and Junction Box Kit		Dimensions: 315 x 195.5 x 225 mm (12.4 x 7.7 x 8.9") Weight: 2.95 kg (6.5 lb)
GV-Mount300	Convex Corner Adapter Kit		Dimensions: 238.6 x 409.5 mm (9.4 x 16.1") Weight: 4.27 kg (9.41 lb)
GV-Mount310	Concave Corner Adapter Kit		Dimensions: 123.3 x 393.1 mm (4.9 x 15.5") Weight: 2.96 kg (6.53 lb)
GV-Mount400	Pole Mount Bracket Kit (Ø 4 ~ 6")		Bracket: 241 x 161 mm (9.5 x 6.3") Weight: 1.70 kg (3.75 lb) Steel Strap Diameter: Ø 4 ~ 6"
GV-Mount410	Pole Mount Bracket Kit (Ø 6 ~ 7.5")		Bracket: 241 x 161 mm (9.5 x 6.3") Weight: 1.70 kg (3.75 lb) Steel Strap Diameter: Ø 6 ~ 7.5"
GV-Mount702	Extension Tube		Four options are available. Dimensions: Ø 5.4 x 10 or 20 or 30 or 50 cm (Ø 2.1 x 3.9 or 7.9 or 11.8 or 19.7") Weight: 180 g or 390 g or 550 g or 800 g (0.4 lb or 0.86 lb or 1.21lb or 1.76 lb)
GV-Mount900	Wall Mount Bracket		Dimensions: 154 x 108 x 50 mm (6.1 x 4.3 x 2") Weight: 240 g (0.53 lb)
GV-Mount909	Wall Box Mount		Dimensions: 170 x 150 x 110 mm (6.7 x 5.9 x 4.3") Weight: 610 g (1.34 lb)

GV-Mount910	Power Box Mount Bracket		Dimensions: 112 x 98 x 7.5 mm (4.4 x 3.9 x 0.3") Weight: 105 g (0.23 lb)
GV-Mount913	Power Box Mount Bracket		Dimensions: Ø 146 x 7.5 mm (Ø 5.7 x 0.3") Weight: 180 g (0.4 lb)
GV-Mount915	In-Ceiling Mounting Kit for GV-EFD2101 / 3101 / 5101		Dimensions: Ø 172.5 x 63.8 mm (Ø 7.04 x 2.5") Weight: 424 g (0.93 lb)
GV-Mount917	GV-EFD2101 / 3101 / 5101 Dome Housing		Dimensions: Ø 186 x 97.5 mm (Ø 7.3 x 3.8") Weight: 948 g (2.09 lb)
GV-PA191 PoE Adapter			Dimensions (H x W x D): 43 x 69 x 40 mm (1.69 x 2.72 x 1.57") Weight: 130 g (0.29 lb)
GV-POE Switch	The GV-POE Switch is designed to provide power along with network connection for IP devices. The GV-POE Switch is available in various models with different numbers and types of ports.		
Power Adapter	Contact your sales representative for the countries and areas supported.		