

## GV-BX1500D-E 1.3MP H.264 Super Low Lux WDR IR Arctic Box IP Camera



- 1.3 megapixel progressive scan super low lux CMOS
- Min. illumination at 0.01 lux
- Dual streams from H.264 and MJPEG
- Up to 30 fps at 1280 x 1024
- Day / Night function (with removable IR-cut filter)
- Vandal resistance (IK10 for metal casing)
- Ingress protection (IP67)
- Built-in heater and fan
- Support for TV-out
- Two-way audio
- Wide Dynamic Range (WDR)
- 3D DNR (Digital Noise Reduction)
- Defog
- Motion detection
- Tampering alarm
- Privacy mask
- Text overlay
- IP address filtering
- Power supplied through PoE (IEEE 802.3at)
- Megapixel lens
- Support for iPhone, iPad, Android and 3GPP
- 31 languages on Web interface
- ONVIF (Profile S) conformant

### Active Tampering Alarm

Tampered



Focus Change



Camera Shift

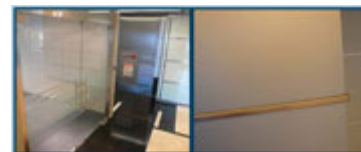

### Introduction

The GV-BX1500-E is an outdoor camera (**IP67** and **IK10**) designed for environments of extreme temperatures. Being a day-and-night camera, it is also equipped with a super low lux CMOS sensor with which the camera is capable of providing a color live view in near darkness.

### Dimensions

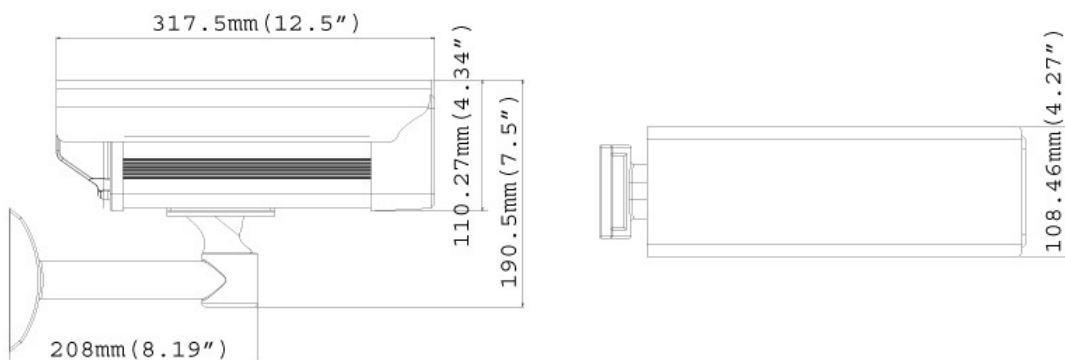

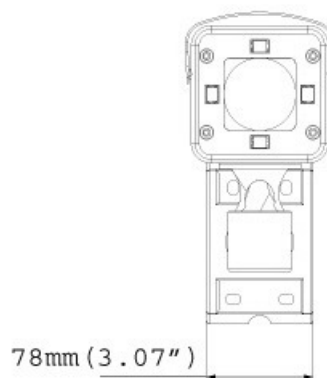
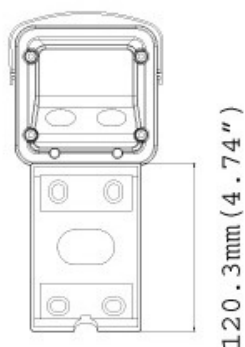

## Specifications

Camera		
Image Sensor	1/3" progressive scan super low lux CMOS	
Picture Elements	1280 (H) x 1024 (V)	
Minimum Illumination	Color	0.01 Lux
	B/W	0.01 Lux
	IR ON	0 Lux
Shutter Speed	Automatic, Manual (1/5 ~ 1/8000 sec.)	
White Balance	Automatic, Manual (2800 ~ 8500K)	
Gain Control	Automatic	
S/N Ratio	55 dB	
WDR	Yes	
Lens		
Megapixel	Yes	
Day/Night	Yes (with removable IR-cut filter)	
Lens Type	Varifocal	
Focal Length	3 ~ 10.5 mm	
Maximum Aperture	F/1.4	
Mount	CS	
Image Format	1/2.7"	
Operation	Focus	Manual (w/lock)
	Zoom	Manual (w/lock)
	Iris	DC drive
IR Quantity	4	
Max. IR Distance	15 m (50 ft.)	
Torque (Focus/Zoom screws)	0.049 N.m	
Operation		
Video Compression	H.264, MJPEG	
Video Stream	Dual streams from H.264 and MJPEG	
Frame Rate	30 fps at 1280 x 1024 * The frame rate and performance may vary depending on the number of connections and data bitrates (different scenes).	
Image Setting	Brightness, Contrast, Saturation, Sharpness, Gamma, White Balance, Flicker-less, Image Orientation, Shutter Speed, D/N Sensitivity, Backlight Compensation, WDR, Defog, Super Low Lux	
Audio Compression	G.711	
Two-way Audio	Yes	
Video Resolution		
Main Stream	4:3	1280 x 960, 640 x 480, 320 x 240
	16:9	1280 x 720, 640 x 360, 448 x 252
	5:4	1280 x 1024, 640 x 512, 320 x 256
Sub Stream	4:3	640 x 480, 320 x 240
	16:9	640 x 360, 448 x 252
	5:4	640 x 512, 320 x 256





Network		
Interface	10/100 Ethernet	
Protocol	HTTP, HTTPS, TCP, UDP, SMTP, FTP, DHCP, NTP, UPnP, DynDNS, 3GPP/ISMA, RTSP, PSIA, SNMP, QoS (DSCP), ONVIF (Profile S)	
Mechanical		
Camera Angle Adjustment	Pan	0° ~ 330°
	Tilt	0° ~ 90°
Temperature Detector	Yes	
	Power	PoE
	Ethernet	Ethernet (10/100 Base-T), RJ-45 cable
Connectors	Audio	1 In (externally connecting a microphone) 1 Out (Stereo phone jack, 3.5 mm / 0.14")
	Auto Iris	DC drive
	TV-Out	BNC connector (640 x 480 resolution)
LED Indicator	1 (Status LED)	
General		
Environment Temperature	Start-up	-30°C ~ 50°C (-22°F ~ 122°F)
	Operation	-40°C ~ 50°C (-40°F ~ 122°F)
Humidity	10% to 90% (no condensation)	
Power Source	PoE (IEEE802.3at)	
Max. Power Consumption	20 W	
Dimensions (L X W X H)	100.5 x 100.5 x 317.5 mm (3.96" x 3.96" x 12.5")	
Weight	3.2 Kg (7.11 lb)	
Heater On	-40°C ~ 8°C (-40°F ~ 46.4°F)	
Fan	Constantly on	
Ingress Protection	IP67	
Vandal Resistance	IK10 for metal casing	
Regulatory	CE, FCC, C-Tick, RoHS compliant	
Power over Ethernet		
PoE Standard	IEEE 802.3at Power over Ethernet / PD	
PoE Power Supply Type	End-Span	
PoE Power Output	Per Port 48V DC, 600mA. Max. 34.2 watts	
Web Interface		
Installation Management	Web-based configuration	
Maintenance	Firmware upgrade through Web Browser or Utility	
Access from Web Browser	Camera Live View, Video Recording, Change Video Quality, Bandwidth Control, Image Snapshot, Digital I/O Control, Audio, Picture in Picture, Picture and Picture, Privacy Mask, Tampering Alarm, Text Overlay, Digital PTZ	
Language	Arabic / Bulgarian / Czech / Danish / Dutch / English / Finnish / French / German / Greek / Hebrew / Hungarian / Indonesian / Italian / Japanese / Lithuanian / Norwegian / Persian / Polish / Portuguese / Romanian / Russian / Serbian / Simplified Chinese / Slovakian / Slovenian / Spanish / Swedish / Thai / Traditional Chinese / Turkish	
Applications		
Network Storage	GV-NVR, GV-System, GV-Backup Center, GV-Recording Server	
Smart Device Access	GV-Eye for Android smartphone, tablet, iPhone, and iPod Touch GV-Eye HD for iPad	
Live Viewing	IE, mobile phone	
CMS Server support	GV-Control Center, GV-Center V2, GV-VSM	

**Note:** Specifications are subject to change without notice.

### Packing List

- |                         |                                     |
|-------------------------|-------------------------------------|
| 1. IR Arctic Box Camera | 7. Silica Gel Bag x 2               |
| 2. Screw Anchor x 4     | 8. GV-IPCAM H.264 Quick Start Guide |
| 3. Screw x 4            | 9. GV-IPCAM H.264 Software CD       |
| 4. Washer x 4           | 10. GV-NVR Quick Start Guide        |
| 5. Big Torx Wrench      | 11. GV-NVR Software DVD             |
| 6. Small Torx Wrench    |                                     |

## Accessories

Model No.	Name	Details
GV-Mount300	Convex Corner Adapter Kit	<p>Dimensions: 238.6 x 409.5 mm (9.4" x 16.1")</p> <p>Weight: 4.27 Kg (9.41 lb)</p> 
GV-Mount310	Concave Corner Adapter Kit	<p>Dimensions: 238.6 x 409.5 mm (9.4" x 16.1")</p> <p>Weight: 4.27 Kg (9.41 lb)</p> 
GV-Mount400	Pole Mount Bracket Kit (Ø 4" ~ 6")	<p>Dimensions</p> <p>Bracket: 241 x 161 mm (9.5" x 6.3")</p> <p>Weight: 1.70 Kg ( 3.75 lb)</p> <p>Steel Strap Diameter: Ø 4" ~ 6"</p> 
GV-Mount410	Pole Mount Bracket Kit (Ø 6" ~ 7.5")	<p>Dimensions</p> <p>Bracket: 241 x 161 mm (9.5" x 6.3")</p> <p>Weight: 1.70 Kg (3.75 lb)</p> <p>Steel Strap Diameter: Ø 6" ~ 7.5"</p> 
GV-PA481 PoE Power Adapter		The GV-PA481 PoE adapter is designed to provide power and network connection to GV-BX1500-E / 2400-E / 3400-E / 5300-E over a single Ethernet cable.
GV-POE Switch		The GV-POE Switch is designed to provide power along with network connection for IP devices. The GV-POE Switch is available in various models with different numbers and types of ports.

