

GV-VD2440 2MP H.264 3x zoom WDR Pro IR Vandal Proof IP Dome



- 1/3.2" progressive scan CMOS
- Dual streams from H.264 and MJPEG
- Up to 30 fps at 1920 x 1080
- Vandal resistance (IK10+)
- Ingress protection (IP67)
- Motorized varifocal lens for remote focus/zoom adjustment
- 3-axis mechanism (pan / tilt / roll)
- Removable IR-cut filter for Day/Night function
- High power IR LEDs
- Intelligent IR
- IR distance up to 20 m (65.6 ft.)
- External microphone
- 2-way audio
- One sensor input and alarm output
- TV-out support
- Built-in micro SD card slot (SD/SDHC) for local storage
- DC12V / AC24V / PoE (IEEE 802.3at)
- Wide Dynamic Range Pro (WDR Pro)
- 2D noise reduction
- Defog
- Motion detection
- Tampering alarm
- Privacy mask
- IP address filtering
- Supports iPhone, iPad, Android & 3GPP
- 31 languages on Web interface
- ONVIF (Profile S) conformant

*No Memory card slot & local storage function for Argentina.

Active Tampering Alarm

Tampered



Focus Change



Camera Shift

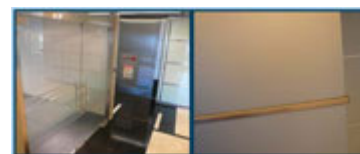

Introduction

GV-VD2440 is an outdoor camera designed with IK10+ vandal resistance and IP67 ingress protection. With its motorized varifocal lens, the user can zoom and focus the camera from the Web interface. The camera is equipped with a WDR Pro with which the camera can process scenes containing contrasting intensity of lights and produce clear images. This night vision is enhanced with its high power LEDs with up to 20 m (65.6 ft.) effective distance.

Overview



Dimensions

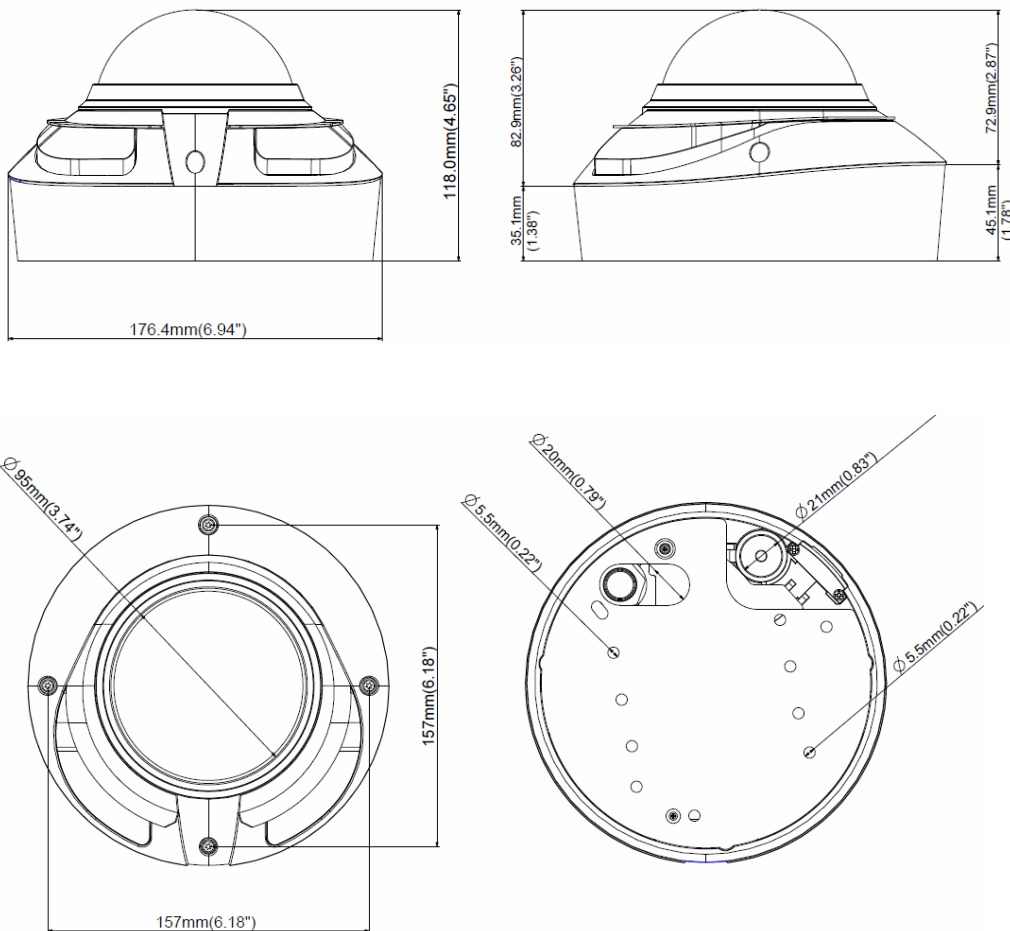

Specifications

Camera		
Image Sensor		1/3.2" progressive scan CMOS
Picture Elements		1920 (H) x 1080 (V)
Minimum Illumination	Color	0.08 Lux
	B/W	0.05 Lux
	IR ON	0 Lux
Shutter Speed		Automatic, Manual (1/5 ~ 1/8000 sec.)
White Balance		Automatic, Manual (2800K ~ 8500K)
Gain Control		Automatic
S/N Ratio		47 dB
WDR Pro		Yes (with WDR sensor)
Lens		
Megapixel		Yes
Day / Night		Yes (with removable IR-cut filter)
Lens Type		Motorized varifocal lens
Focal Length		3 ~ 9 mm
Maximum Aperture		F/1.2
Mount		Ø 14 mm
Image Format		1/2.7"
Horizontal FOV		82°~30°
Operation	Focus	Auto Focus
	Zoom	3X Optical Zoom
	Iris	DC drive
High Power IR LED Quantity		6 IR LEDs
Max. IR Distance		20 m (65.6 ft.)
Operation		
Video Compression		H.264, MJPEG
Video Stream		Dual streams from H.264 and MJPEG
Frame Rate		30 fps at 1920 x 1080
		*The frame rate and the performance may vary depending on the number of connections and data bitrates (different scenes).
Image Setting		Brightness, Contrast, Sharpness, Gamma, White Balance, Flicker-less, Image Orientation, Backlight Compensation, D/N Sensitivity, Shutter Speed, WDR, Defog, Zoom, Focus Change, Denoise, Metering
Audio Compression		G.711, AAC (optional)
Audio Support		Two-Way Audio
Sensor Input		1 Input (Dry Contact)
Alarm Output		1 Output (200mA 5V DC)
Video Resolution		
Main Stream	4:3	1600 x 1200, 1280 x 960, 640 x 480, 320 x 240
	16:9	1920 x 1080, 1280 x 720, 640 x 360, 448 x 252
	5:4	1280 x 1024, 640 x 512, 320 x 256
Sub Stream	4:3	640 x 480, 320 x 240
	16:9	640 x 360, 448 x 252
	5:4	640 x 512, 320 x 256
Network		
Interface		10/100M Ethernet
Ethernet Protocol		DHCP, DynDNS, FTP, HTTP, HTTPS, NTP, ONVIF (Profile S), PSIA, QoS (DSCP), RTSP, SNMP, SMTP, TCP, UDP, UPnP, 3GPP/ISMA
Mechanical		
Temperature Detector		Yes
Camera Angle Adjustment	Pan	-90° ~ 90°
	Tilt	0° ~ 85°
	Rotate	0° ~ 350°
Connectors	Power	2-pin terminal block, PoE
	Ethernet	Ethernet (10/100 Base-T), RJ-45 cable

Mechanical		
Connectors	Audio	1 In (3.5mm phone jack for microphone) 1 Out (3.5mm phone jack for speaker)
	Digital I/O	3-pin terminal block, pitch 2.5 mm (0.1")
	Local Storage	Micro SD card slot (SD/SDHC, SD version 2.0 only, Class 10) * SDXC and UHS-I card types are not supported.
	TV-Out	BNC connector (640 x 480 resolution)
LED Indicator	2 LEDs: Power, Status	
General		
Environment Temperature	Start-up	-20°C ~ 50°C (-4°F ~ 122°F)
	Operation	
Humidity	10% to 90% (no condensation)	
Power Source	12V DC / 24V AC / PoE (IEEE 802.3at)	
Max. Power Consumption	22.48 W	
Dimensions	Camera Body	ø 176.5 x 118 mm (6.9" x 4.6")
Weight	1.83 kg (4.03 lb)	
Ingress Protection	IP67	
Vandal Resistance	IK10+	
Regulatory	CE, FCC, RCM, RoHS compliant	
Power over Ethernet		
PoE Standard	IEEE 802.3at Power over Ethernet / PD	
PoE Power Supply Type	End-Span	
PoE Power Output	Per Port 48V DC, 600mA. Max. 30 watts	
Web Interface		
Installation Management	Web-based configuration	
Maintenance	Firmware upgrade through Web Browser or Utility	
Access from Web Browser	Camera Live View, Video Recording, Change Video Quality, Bandwidth Control, Image Snapshot, Digital I/O Control, Audio, Picture in Picture, Picture and Picture, Privacy Mask, Visual Automation, Tampering Alarm, Text Overlay, Digital PTZ	
Language	Arabic / Bulgarian / Czech / Danish / Dutch / English / Finnish / French / German / Greek / Hebrew / Hungarian / Indonesian / Italian / Japanese / Lithuanian / Norwegian / Persian / Polish / Portuguese / Romanian / Russian / Serbian / Simplified Chinese / Slovakian / Slovenian / Spanish / Swedish / Thai / Traditional Chinese / Turkish	
Applications		
Network Storage	GV-NVR, GV-System, GV-Backup Center, GV-Recording Server	
Smart Device Access	GV-Eye for iOS and Android	
Live Viewing	IE, mobile phone	
CMS Server support	GV-Control Center, GV-Center V2, GV-VSM	

Note:







- Do not use clothes or any ordinary material to clean the camera cover since they may result in scratches.
- Specifications are subject to change without notice.
- Mind the following when using a memory card for recording:
 - Recorded data on the memory card can be damaged or lost if the data are accessed while the camera is under physical shock, power interruption, memory card detachment or when the memory card reaches the end of its lifespan. No guarantee is provided for such causes.
 - To avoid power outage, it is highly suggested to apply a battery backup (UPS).
 - For better performance, it is highly suggested to use Micro SD card of MLC NAND flash, Class 10.
 - Replace the memory card when its read/write speed is lower than 6 MB/s or when the memory card is frequently undetected by the camera.

Packing List

- | | |
|-------------------------|--------------------------------------|
| 1. Vandal Proof IP Dome | 12. Flat Screw |
| 2. Torx Wrench | 13. Short Screw x 2 |
| 3. 3-Pin Terminal Block | 14. Silica Gel Bag |
| 4. Audio Wires | 15. Sticker (for Silica Gel Bag) |
| 5. Power Adapter | 16. Ruler |
| 6. TV Out Wire | 17. Conduit Converter |
| 7. RJ-45 Connector x 2 | 18. PG21 Conduit Connector |
| 8. Back Plate | 19. GV-IPCAM H.264 Software CD |
| 9. Installation Sticker | 20. GV-IPCAM H.264 Quick Start Guide |
| 10. Screw Anchor x 4 | 21. GV-NVR Software DVD |
| 11. Long Screw x 4 | 22. GV-NVR Quick Start Guide |

Accessories

Model No.	Name		Details
GV-Mount100	Straight Tube and Junction Box Kit		Dimensions: 200 x 170 x 257.5 mm (7.9" x 6.7" x 10.1") Weight: 3.17 kg (6.99 lb)
GV-Mount101	Straight Tube Kit		Dimensions: 219 x 125 x 332 mm (8.6" x 4.9" x 13.1") Weight: 1.8 kg (3.97 lb)
GV-Mount200	Wall Pendant Tube		Dimensions: 225 x 140 x 250 mm (8.9" x 5.5" x 9.8") Weight: 900 g (1.98 lb)
GV-Mount203	Wall Pendant Tube and Junction Box Kit		Dimensions: 315 x 195.5 x 225 mm (12.4" x 7.7" x 8.9") Weight: 2.95 kg (6.5 lb)
GV-Mount205	Wall Mount Bracket Kit		Dimensions: 126.5 x 203 x 160 mm / 5 x 8 x 6.3" (L x W x diameter) Weight: 0.5 kg / 1.1 lb

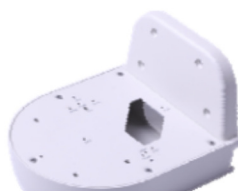
Model No.	Name		Details
GV-Mount300	Convex Corner Adapter Kit		Dimensions: 238.6 x 409.5 mm (9.4" x 16.1") Weight: 4.27 kg (9.41 lb)
GV-Mount310	Concave Corner Adapter Kit		Dimensions: 238.6 x 409.5 mm (9.4" x 16.1") Weight: 4.27 kg (9.41 lb)
GV-Mount400	Pole Mount Bracket Kit (\varnothing 4" ~ 6")		Dimensions Bracket: 241 x 161 mm (9.5" x 6.3") Weight: 1.70 kg (3.75 lb) Steel Strap Diameter: \varnothing 4" ~ 6"
GV-Mount410	Pole Mount Bracket Kit (\varnothing 6" ~ 7.5")		Dimensions Bracket: 241 x 161 mm (9.5" x 6.3") Weight: 1.70 kg (3.75 lb) Steel Strap Diameter: \varnothing 6" ~ 7.5"
GV-Mount702	Extension Tube		Four options are available. Dimensions: \varnothing 5.4 x 10 or 20 or 30 or 50 cm (\varnothing 2.1" x 3.9" or 7.9" or 11.8" or 19.7") Weight: 180 g or 390 g or 550 g or 800 g (0.4 lb or 0.86 lb or 1.21lb or 1.76 lb)
GV-Mount900	Wall Mount Bracket		Dimensions: 154 x 108 x 50 mm (6.1" x 4.3" x 2") Weight: 240 g (0.53 lb)
GV-Mount903	GV-VD Series Dome Housing		Dimensions: \varnothing 186 x 97.5 mm (\varnothing 7.3" x 3.8") Weight: 600 g (1.32 lb)
GV-Mount909	Wall Mount Bracket		Dimensions: 170 x 150 x 110 mm (6.7" x 5.9" x 4.3") Weight: 610 g (1.34 lb)

Model No.	Name	Details
GV-Relay V2	GV-Relay V2	<div data-bbox="673 226 868 346" data-label="Image"> </div> <p>The GV-Relay V2 is designed to expand the voltage load of GV IP devices. It provides 4 relay outputs, and each can be set as normally open (NO) or normally closed (NC) independently as per your requirement.</p>
Power Adapter	<p>Power adapters are available in 6 regions: Argentina, Australia, Brazil, Europe, U.K and U.S.</p> <p>*This item does not include a power cord.</p>	
GV-POE Switch	<p>The GV-POE Switch is designed to provide power along with network connection for IP devices. The GV-POE Switch is available in various models with different numbers and types of ports.</p>	
Metal PG21 Conduit Connector		<div data-bbox="722 556 820 661" data-label="Image"> </div> <p>The metal PG21 conduit connector allows you to run the wires through a 3/4" conduit pipe.</p>

