

GV-EDR2100 Series 2MP H.264 Low Lux WDR IR Mini Fixed Rugged IP Dome



- 1/2.8" progressive scan low lux CMOS
- Dual streams from H.264 and MJPEG
- Up to 30 fps at 1920 x 1080
- Intelligent IR
- Day and Night function (with removable IR-cut filter)
- Vandal resistance (IK10 for metal casing)
- Ingress protection (IP67)
- 2-axis mechanism (pan / tilt)
- Wide Dynamic Range (WDR)
- Defog
- Motion detection
- Tampering alarm
- Text overlay
- Privacy mask
- IP address filtering
- DC 12V / PoE
- Megapixel lens
- Supports iPhone, iPad, Android & 3GPP
- 31 languages on Web interface
- ONVIF (Profile S) conformant

Introduction

The Target Mini Fixed Rugged Dome is an outdoor, fixed, mini-sized network camera equipped with an automatic IR-cut filter and IR LEDs for day and night surveillance. The camera adheres to IK10 and IP67 standards. It is adjustable in 2 axis (pan and tilt) and can be connected through PoE.

Models

Model	Iris	Focal Length (mm)	Maximum Aperture	Image Format
GV-EDR2100-0F	Fixed	2.8	F/2.0	1/2.7"
GV-EDR2100-2F	Fixed	3.8	F/1.8	1/2.7"

Active Tampering Alarm

Tampered



Focus Change



Camera Shift



Dimensions

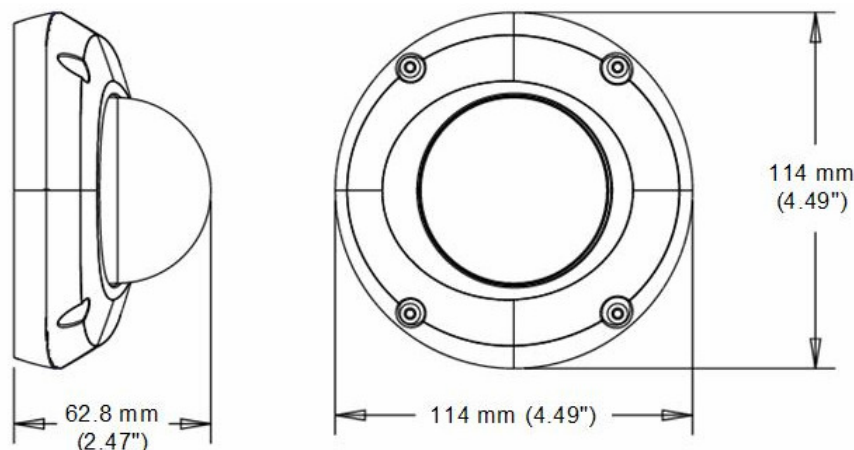

Specifications

Camera	GV-EDP2100-0F		GV-EDP2100-2F
Image Sensor	1/2.8" progressive scan low lux CMOS		
Picture Elements	1920 (H) x 1080 (V)		
Minimum Illumination	Color	0.07 Lux	
	B/W	0.04 Lux	
	IRON	0 Lux	
Shutter Speed	Automatic, Manual (1/5 ~ 1/8000 sec.)		
White Balance	Automatic, Manual (2800K ~ 8500K)		
Gain Control	Automatic		
S/N Ratio	48 dB		
WDR	Yes		
Dynamic Range	Up to 72 dB		
Lens			
Megapixel	Yes		
Day/Night	Yes (with removable IR-cut filter)		
Focal Length	2.8 mm	3.8 mm	
Lens Type	Fixed		
Maximum Aperture	F/2.0	F/1.8	
Mount	M12, Pitch 0.5 mm		
Horizontal FOV	99°	72°	
Image Format	1/2.7"		
Operation	Focus	Fixed	
	Zoom	Fixed	
	Iris	Fixed	
IRLED Quantity	12 IRLEDs		
Max. IR Distance	15 m (50 ft)		
Operation			
Video Compression	H.264, MJPEG		
Video Streaming	Dual streams from H.264 and MJPEG		
Frame Rate	30 fps at 1920 x 1080 * The frame rate and the performance may vary depending on the number of connections and data bitrates (different scenes).		
Image Setting	Brightness, Contrast, Saturation, Sharpness, Gamma, White Balance, Flicker-less, Image Orientation, Shutter Speed, D/N Sensitivity, Backlight Compensation, WDR, Defog		
Audio Support	N/A		

Video Resolution		
Main Stream	4:3	1280 x 960, 640 x 480, 320 x 240
	16:9	1920 x 1080, 1280 x 720, 640 x 360, 448 x 252
	5:4	1280 x 1024, 640 x 512, 320 x 256
Sub Stream	4:3	640 x 480, 320 x 240
	16:9	640 x 360, 448 x 252
	5:4	640 x 512, 320 x 256
Network		
Interface	10/100 Ethernet	
Ethernet Protocol	DHCP, DynDNS, FTP, HTTP, HTTPS, NTP, ONVIF (Profile S), QoS(DSCP), RTSP, SNMP, SMTP, TCP, UDP, UPnP, 3GPP/ISMA	
Mechanical		
Camera Angle Adjustment	Pan	-45° ~ 45°
	Tilt	0° ~ 63°
Connectors	Power	2-pin terminal block, PoE
	Ethernet	Ethernet (10/100 Base-T), RJ45 cable
LED Indicator	4 LEDs: Link, ACT, Power, Status	
General		
Environment Temperature	Start-up	-20°C ~ 50°C (-4°F ~ 122°F)
	Operation	-30°C ~ 50°C (-22°F ~ 122°F)
Humidity	10% to 90% (no condensation)	
Power Source	12V DC / PoE (IEEE 802.3af)	
Max. Power Consumption	5.8 W	
Dimension	ø 114 x 62.8 mm (4.49" x 2.47")	
Weight	600 g (1.32 lb)	
Ingress Protection	IP67	
Vandal Resistance	IK10 for metal casing	
Regulatory	CE, FCC, RCM, RoHS compliant	
Power over Ethernet		
PoE Standard	IEEE 802.3af Power over Ethernet / PD	
PoE Power Supply Type	End-Span	
PoE Power Output	Per Port 48V DC, 350mA. Max. 15.4 watts	
Web Interface		
Installation Management	Web-based configuration	
Maintenance	Firmware upgrade through Web Browser or Utility	
Access from Web Browser	Camera Live View, Video Recording, Change Video Quality, Bandwidth Control, Image Snapshot, Audio, Picture in Picture, Picture and Picture, Privacy Mask, Text Overlay, Digital PTZ	
Language	Arabic / Bulgarian / Czech / Danish / Dutch / English / Finnish / French / German / Greek / Hebrew / Hungarian / Indonesian / Italian / Japanese / Lithuanian / Norwegian / Persian / Polish / Portuguese / Romanian / Russian / Serbian / Simplified Chinese / Slovakian / Slovenian / Spanish / Swedish / Thai / Traditional Chinese / Turkish	
Applications		
Network Storage	GV-NVR, GV-System, GV-Recording Server	
Smart Device Access	GV-Eye for Android smartphone, tablet, iPhone, iPod Touch, and iPad	
Live Viewing	IE, mobile phone	
CMS Server support	GV-Control Center, GV-Center V2, GV-VSM	





Note: Specifications are subject to change without prior notice.



Packing List

- | | |
|---|--------------------------------------|
| 1. Target Mini Fixed Rugged Dome | 11. Silica Gel Bag x 2 |
| 2. Screw x 2 | 12. Sticker (for Silica Gel Bag) x 2 |
| 3. Screw Anchor x 2 | 13. Concave hexagon Wrench |
| 4. Focus Adjustment Clip | 14. Ruler |
| 5. Installation Sticker | 15. Screw for Conduit Converter x 2 |
| 6. Conduit Converter | 16. GV-IPCAM H.264 Quick Start Guide |
| 7. RJ45 Connector | 17. GV-IPCAM H.264 Software CD |
| 8. Waterproof rubber set (for RJ45) | 18. GV-NVR Quick Start Guide |
| 9. Waterproof rubber set (for RJ45 and DC12V) | 19. GV-NVR Software DVD |
| 10. Torx Wrench | |

Note: Power adapters can be purchased upon request.

Accessories

Model No./Name	Details
GV-Mount900 Wall Mount Bracket	Dimensions: 154 x 108 x 50 mm (6.1" x 4.3" x 2") Weight: 240 g (0.53 lb)
	
GV-Mount909 Wall Mount Bracket	Dimensions: 170 x 150 x 110 mm (6.7" x 5.9" x 4.3") Weight: 610 g (1.34 lb)
	
GV-Mount910 Power Box Mount Bracket	Dimensions: 112 x 98 x 7.5 mm (4.4" x 3.9" x 0.3") Weight: 105 g (0.23 lb)
	
GV-Mount913 Power Box Mount Bracket	Dimensions: Ø 146 x 7.5 mm (Ø 5.7" x 0.3") Weight: 180 g (0.4 lb)
	

Model No./Name	Details
<p>GV-PA191 PoEAdapter</p> 	<p>Weight: 130 g (0.29 lb) Dimensions (H x W x D): 43 x 69 x 40 mm (1.69" x 2.72" x 1.57")</p>
<p>Plastic PG21 Conduit Connector</p> 	<p>The plastic PG21 conduit connector is used for running the wires of the camera through a 1/2" conduit pipe.</p>
<p>Power Adapter</p>	<p>Power adapters are available in 4 regions: U.S.A., Australia, U.K and Europe.</p>
<p>GV-POESwitch</p>	<p>The GV-POE Switch is designed to provide power along with network connection for IP devices. The GV-POE Switch is available in various models with different numbers and types of ports.</p>

