



IP816A-LPC

License Plate Capture Solution

2MP • 3DNR • Remote Back Focus • EIS • P-iris •
60 fps • Snapshot Focus • Corridor View

Overview

VIVOTEK IP816A-LPC represents a total solution for LPC (License Plate Capture) applications by leveraging the top-notch quality and traffic monitoring ability of the IP816A-HP. With the adoption of built-in corresponded IR LEDs and an IR pass filter, the IP816A-LPC delivers clear license plate images for reliable recognition, in both the highest levels of glare, and in the darkest hours of the night.

Empowered with VIVOTEK Scene Mode, which provides different exposure levels to avoid overexposure in some lighting conditions, the IP816A-LPC can capture clear plate images from the vehicles moving at speeds of up to 80km/h.

Value-added features such as EIS (Electronic Image Stabilization) and VIVOTEK Snapshot Focus ensure that the IP816A-LPC can be easily installed and adjusted to provide the perfect LPR solution. Further, with the high-resolution images supporting a wide range of up to two lanes, the IP816A-LPC is also the most economic solution in LPR applications.

Meanwhile, the IP816A-LPC is also integrated with Overseer LPR software, developed by VIT Company, one of the world's most renowned LPR software manufacturers. This synergy further empowers the IP816A-LPC to capture license plate images for any LPR application.



License Plate Recognition

Highlights

- VIVOTEK Scene Mode Design and IR LED for Specific LPC Applications
- Dedicated Design Provides Stable and Reliable 24/7 & Day/Night Performance for Traffic Monitoring
- Specific Exposure Design to Avoid Overexposure and Glare
- Wide Coverage for Dual Lanes to Save Overall Installation Cost
- Value-Added features including VIVOTEK Snapshot Focus, RBF and EIS to support traffic monitoring applications
- Vandal-Proof IK10-rated and Weather-Proof IP66-rated Housing

Network Camera Features

- 2-Megapixel CMOS Sensor
- 30fps @ 1920x1080
60fps @ 1920x1080 (one-stream mode only)
- P-iris Lens
- 3D Noise Reduction for Low-light Conditions
- WDR Pro (100dB) to Provide Extreme Visibility in High Light Contrast Scenes
- RBF (Remote Back Focus) System to Assist for Precise Focus Adjustment
- EIS (Electronic Image Stabilization) to Control Image Stability
- Two-way Audio, Snapshot Focus and Video Rotation for Corridor View



Night Image Capturing Design

Capturing images at night is a challenging issue for any surveillance application, but for License Plate Capture applications the challenge is even greater due to noise and glare caused by the headlights of cars. The IP816A-LPC is equipped with 24W IR LEDs and a delicate IR Pass Filter, which help to filter out reflected light and only capture detailed information from the plates. Moreover, the IR threshold is also programmed to deploy the IR LED automatically to ensure 24/7 & Day/ Night performance.

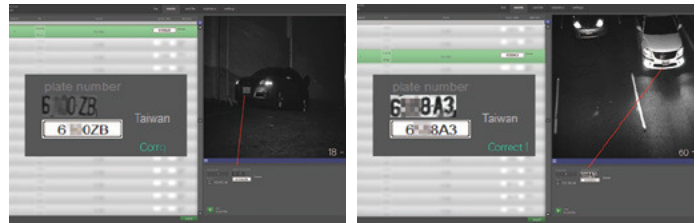

Clear Image Captured with IR LEDs and IR Pass Filter

Selectable LPC Mode for different LPR applications

To save on installation effort and expense when adjusting cameras for optimal LPC image quality, VIVOTEK's Scene-Mode Design includes an LPC mode, which optimizes the shutter speed and AE setup, providing a clear image of plates for positive plate recognition.

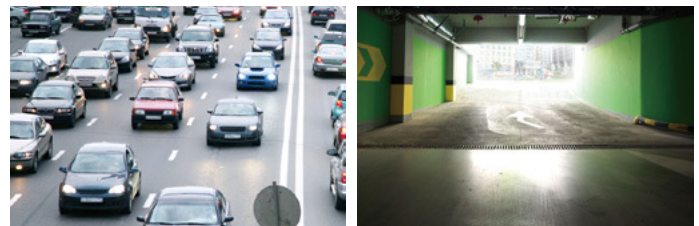

Street

Parking Lot

One Camera to Cover Dual Lanes

The high image quality of the IP816A-LPC ensures wide coverage of two lanes with one Camera, whether used for street monitoring or for parking lot monitoring. With a single IP816A-LPC covering dual lanes, the total cost of traffic monitoring will be reduced.



Wide Coverage of Dual Lanes

Suggested Installation

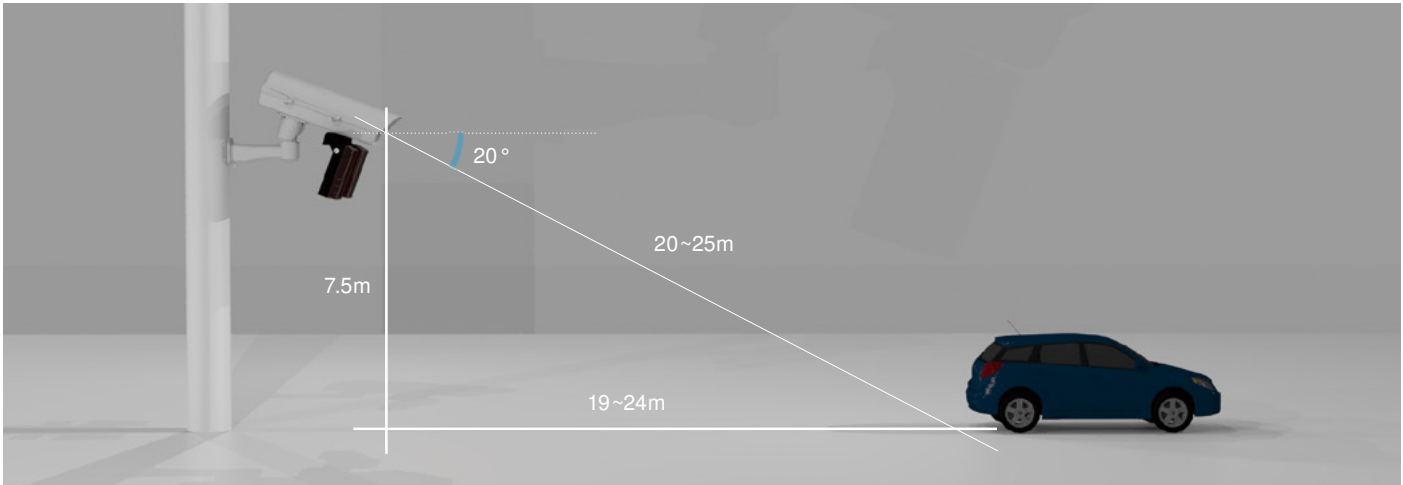

Ordering Information



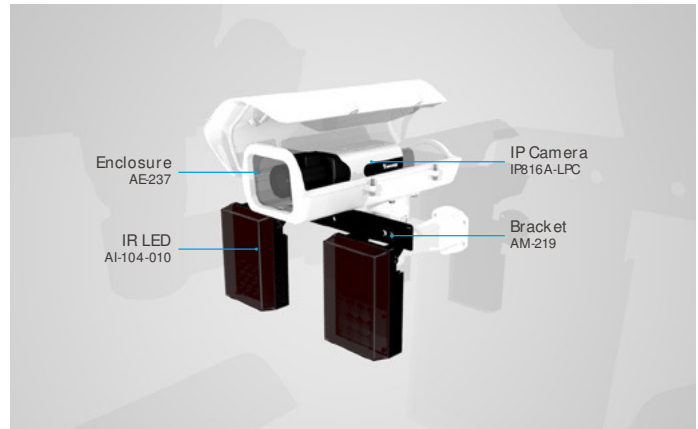

IP816A-LPC (Street)		
Category	Model	Description
IP Camera	IP816A-LPC	2MP, 60fps, WDR Pro, Remote Back Focus, 3DNR, EIS, Snapshot
IR LED	AI-104-010	-40 °C ~ 50 °C, 24W IR LED, 10°, 100m, IK10, IP66, 12~24VDC or 24VAC in
Enclosure	AE237	Outdoor enclosure with -20 °C ~ 50 °C, Defog, Fan, 24V AC in
Bracket	AM-219	L shape bracket

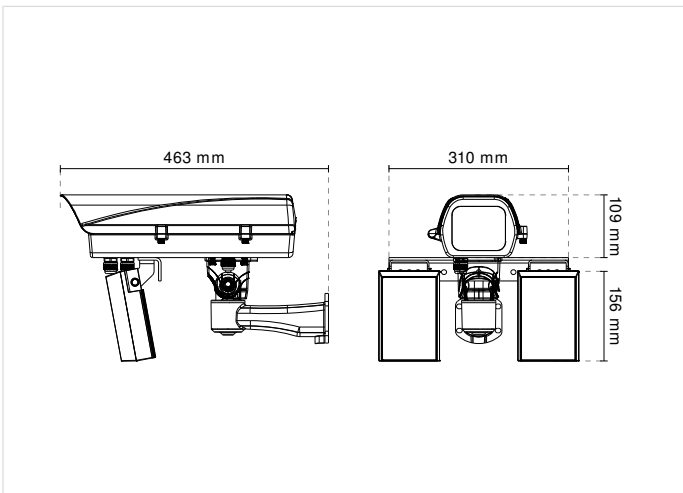

Mechanical Information



Accessory Options

Enclosure	
 <p>AE-241 Outdoor enclosure with 0 °C ~ 50 °C, 50 m IR, Defog, Fan, UPoE in</p>	 <p>AE-242 Outdoor enclosure with -40 °C ~ 50 °C, 50 m IR, Defog, Fan, UPoE in</p>
Fiber Media Converter	
 <p>AW-IHS-0200 Industrial FE Media Converter SC Multi-Mode 2 km</p>	 <p>AW-IHS-0201 Industrial FE Media Converter SC Single-Mode 30 km</p>
IR LED	
 <p>AI-104-035 -40 °C ~ 50 °C, 24W IR LED, 35°, 25m, IK10, IP66, 12~24V DC or 24V AC in</p>	

LPC Solution - Technical Specification

Model	IP816A-LPC (Street)	IR Illuminators	24 W, 10° x 2
IR Threshold	IR on: 300 Lux IR off: 600 Lux	Capture Range	Up to 20 m
		Capture Speed	Up to 80 km/h

Network Camera - Technical Specifications

CPU	Multimedia SoC (System-on-Chip)	Protocols	IPv4, IPv6, TCP/IP, HTTP, HTTPS, UPnP, RTSP, RTP, RTCP, IGMP, SMTP, FTP, DHCP, NTP, DNS, DDNS, PPPoE, CoS, QoS, SNMP, 802.1X, UDP, ICMP
Flash	256 MB	Interface	10Base-T/100Base-TX Ethernet (RJ45) *It is highly recommended to use standard Cat. 5e & Cat. 6 cables which are compliant with the 3P ETL standard.
RAM	384 MB	ONVIF	Supported, specification available at www.onvif.org
Camera Features		Intelligent Video	
Image Sensor	1/1.9" Progressive CMOS	Video Motion Detection	Triple-window video motion detection
Maximum Resolution	1920x1080 (2MP)	Alarm and Event	
Lens Type	Vari-focal	Alarm Triggers	Video motion detection, manual trigger, digital input, periodical trigger, system boot, recording notification, camera tampering detection, audio detection, IR Status
Focal Length	f = 12 ~ 40 mm	Alarm Events	Event notification using digital output, HTTP, SMTP, FTP and NAS server, SD Card File upload via HTTP, SMTP, FTP, NAS server and SD card
Aperture	F2.36 ~ F2.44	General	
Auto-iris	P-Iris	Smart Focus System	RBF (Remote Back Focus)
Field of View	10.2°~ 30°(Horizontal) 8°~ 22°(Vertical) 12°~ 38°(Diagonal)	IP Camera Connectors	RJ45 for Network/ PoE connection Audio input/output BNC Video output AC 24V power input Digital input*3 Digital output*1
Shutter Time	1/800 sec. to 1/10,000sec.	LED Indicator	System power and status indicator
WDR Technology	WDR Pro (Default: Off)	Power Input	AC 24V
Day/Night	Removable IR-cut filter for day & night function	Power Consumption	Max. 77.4W (AC 24V)
Pan/ Tilt/ Zoom Functionalities	ePTZ: 48x digital zoom (4x on IE plug-in, 12x built in)	Weight	5,222g
On-board Storage	SD/ SDHC/ SDXC card slot	Housing	IP66, IK10
Video		Safety Certifications	IP Camera : CE, LVD, FCC Class B, VCCI, C-Tick, UL
Compression	H.264 & MJPEG	Operating Temperature	Starting Temperature: 0 °C ~ 50 °C (14 °F ~ 122 °F) Working Temperature: -10 °C ~ 50 °C (-4 °F ~ 122 °F) Humidity: 90%
Maximum Frame Rate	30fps @ 1920x1080 60fps @ 1920x1080 (In one-stream mode only) (In both compression mode)	Warranty	36 months
Maximum Streams	2 simultaneous streams	System Requirements	
S/N Ratio	50.8 dB	Operating System	Microsoft Windows 8/7/ Vista/ XP 2000
Dynamic Range	100 dB	Web Browser	Mozilla Firefox 7 ~ 10 (streaming only) Internet Explorer 7/8/9/10/11
Video Streaming	Adjustable resolution, quality and bitrate	Other Players	VLC: 1.1.11 or above QuickTime: 7 or above
Image Settings	Time stamp, text overlay, flip & mirror Configurable brightness, contrast, saturation, sharpness, white balance, exposure control, gain, backlight compensation, privacy masks, scheduled profile settings 3D noise reduction, EIS, video rotation, snapshot focus, scene mode	Audio	
Audio		Audio Capability	Two-way audio (full duplex)
Audio Capability	Two-way audio (full duplex)	Compression	AAC, G.711, G.726
Compression	AAC, G.711, G.726	Interface	External microphone input Audio output
Interface	External microphone input Audio output	Network	
Network		Users	Live viewing for up to 10 clients

IR LED - Technical Specifications

Model	AI-104-010	Operating Temperature	-40 °C ~ 50 °C (-40 °F ~ 122 °F)
Max. Distance	100 m	Color	Black
Beam Angle	10°	Wavelength	850nm
Input Power	24V AC 12 to 24V DC	Dimensions	157 x 105 x 80.62 mm
Power Consumption	24W	Included Accessories	U-bracket
Weight	0.85 kg	Certifications	CE, FCC, VCCI, C-TICK
Housing	IP66, IK10	Integrated Control	Built-in photocell for automatic IR on/off

All specifications are subject to change without notice. Copyright © VIVOTEK INC. All rights reserved.

